

**GET MORE PROFIT
OR GIVE THE
TRUCK BACK.***



**NEW MAHINDRA
FURIO**
MORE PROFIT GUARANTEED*

NOW BUYING ANY OTHER TRUCK IS A BIG RISK.

The brand new **Mahindra FURIO** comes with a never-before, industry-first package of 5 promises. Designed around your business needs, these promises assure you the Highest Earnings, Complete Peace of Mind, Best-in-Class Comfort, Safety and Risk-free Ownership Experience. In fact, this truck will transform your business in such a big way that buying any other truck would be a big risk.



**HIGHER PAYLOAD-
HIGHER PROFIT GUARANTEED**



**BEST-IN-CLASS MILEAGE WITH
FUELSMART TECHNOLOGY-
HIGHER PROFIT GUARANTEED**



**BEST-IN-CLASS CABIN-
BETTER COMFORT, SAFETY AND
CONVENIENCE GUARANTEED**



**5 YEARS / 5 Lakh km
TRANSFERABLE WARRANTY-
PEACE OF MIND GUARANTEED**



**5 YEARS UNLIMITED km AMC FREE*-
FREE MAINTENANCE GUARANTEED**

MAHINDRA FURIO **BS6** - A BIG LEAP FOR INDIAN TRANSPORT.

This truck has everything it needs to transform the entire transport industry in India. Styled at the famous Italian automobile design and engineering company, Pininfarina, the Mahindra **FURIO** is crafted with striking looks and gives the assurance of outstanding performance. This proud addition to our truck range marks a new dawn for the Intermediate Commercial Vehicle (ICV) category and makes Mahindra a full range commercial vehicle player.



**WHEN YOU DELIVER HIGHER PROFITS,
PEACE OF MIND AND PROSPERITY,
THE WORLD ACKNOWLEDGES IT!
NOT ONCE, NOT TWICE, BUT 3 TIMES!**

CV of The Year: Mahindra FURIO

ICV Cargo Carrier of The Year: Mahindra FURIO 14



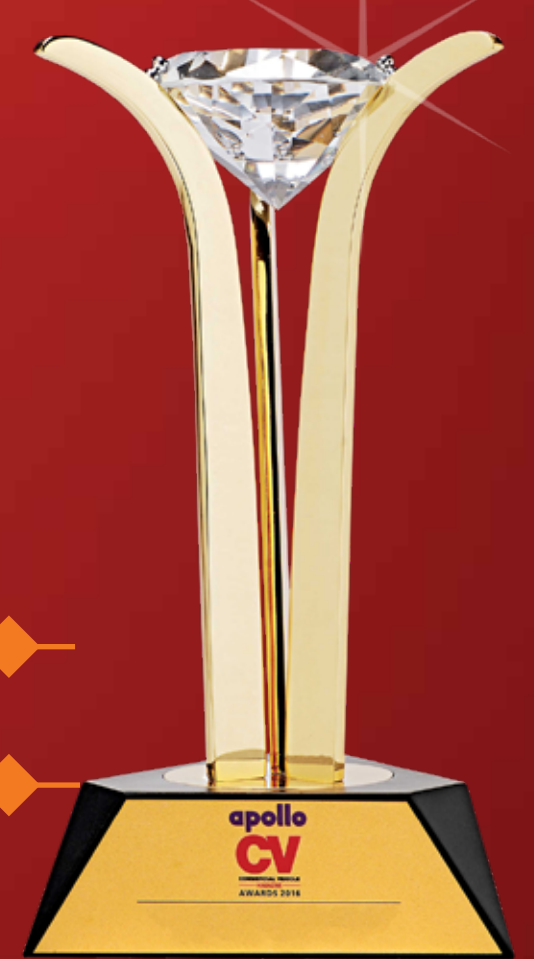



Special Application CV of The Year: Mahindra FURIO 12 Reefer



DOUBLE YOUR EARNINGS BASKET.

The Mahindra **FURIO** is the perfect ICV for delivering fruits and vegetables. What makes Mahindra **FURIO** the best bet for your business is that it gives you the assurance no other truck in its class does: two times more earnings per year*.

So what's the secret behind this truck's unique profitability?

-  Higher mileage means more savings every trip
-  Higher load carrying capability gives you more earnings per delivery
-  Higher vehicle reliability
-  Superior driving performance
-  Higher driver comfort leads to more trips and more earnings
-  Higher safety which gives drivers the reassurance to drive in the nights and add to earnings
-  Best fit load body dimensions suitable for crates and sacks



READY TO RUN FROM DAY ONE. READY TO DELIVER PROFIT FROM DAY ONE.

The Mahindra **FURIO** is engineered to earn. That too from the very first day itself. It has been made from the ground up with your business in mind and hence needs minimal modifications.

Take a look:



Provision for Rooftop Luggage Carrier (RLC)

Robust Front Structure for greater strength and safety

Boltable and Removable Semicircular Canopy, for easy tarpaulin fitment

High Strength Low Alloy (with Grade 420 Panels) needs no extra reinforcement



Higher Number of Extra Large Hooks makes it easy for double knots

Dense Pitch Side Pillars offer better load support and prevent panel deformation

Higher Canopy Height and Two Additional Bars make it ideal for high stack loading



Side Ladder for easy access to the roof

Perfect Dimensions for Loading Crates and Sacks (with 2135 mm, 2288 mm and 2374 mm width models)



Five Hinges on Tail Panel for added strength



MODEL TECHNICAL SPECIFICATIONS - FRUIT AND VEGETABLE



Model	FURIO 11	FURIO 12	FURIO 14	FURIO 16
GVW	11280 kg	11990 kg	14050 kg	16140 kg
Tyres	235/75 R17.5, 8.25 x 16	8.25 R 20		9.0 R 20
Engine	mDi Tech, 4 Cylinder, BS-VI (EGR + SCR Technology)			
Max. Power	103 kW @ 2400 r/min			
Max. Torque	525 Nm @ 1250-1800 r/min (With Multimode)			
Transmission	MNT 55, 6 speed Overdrive Synchro Gearbox			
Clutch Diameter	362 mm			
Chassis (mm)	HSLA 550, 210 x 65 x 5	HSLA 550, 210 x 65 x 6		HSLA 550, 212 x 65 x 7
Fuel Tank	160 litre	190 litre		235 litre
Suspension	Front : Parabolic, Rear : Semi Elliptical			
Brakes	8 Bar System	10 Bar System		
Cabin	2.05 m Day	2.05 m Day		2.05 m Day, Sleeper
Load Body Length	5334 mm, 6711 mm	5796 mm, 6100 mm, 6711 mm, 7320 mm		5798 mm, 6098 mm, 6711 mm, 7315 mm
Load Body Width	2135 mm	2135 mm, 2288 mm		2288 mm, 2374 mm
LB Side Pillars	10 Nos	13 Nos	14 Nos	13 Nos 14 Nos
LB Canopy (Height)	1745 mm	1900 mm		1980 mm







FRUIT AND VEGETABLE MODEL - FEATURES

Features	FURIO	Comp. 1	Comp. 2		
Engine	Hydraulic Lash Adjuster	√	x	x	
	Auto Belt Tensioner	√	x	x	
Safety	Cab - Energy Absorbing Mounts	√	x	x	
	Wide Spread Fog Lamps	√	x	x	
	Neutral Safety Start Switch	√	x	x	
	Anti-Roll Bar	√	x	Option	
	Wire Mesh @ Fuel Tank Neck	√	x	x	
Comfort	SL Berth - Day Cab*	√	x	x	
	Lounging Arrangement (Co Driver Side)	√	x	x	
	Air Outlets - Ventilation	8# Vents	4# Vents	4# Vents	
	5 Deg. Cooler Cab (Lower Rake Angle Design)	√	x	x	
	Centre Seat cum Storage Day Cab	√	x	x	
	Sleeping Provision – Day Cab (Centre Seat)	√	x	x	
	Convenience	Roof Luggage Carrier / Aero Kit	√	x	x
		Mounting Provision	√	x	x

TRIPLE THE SIZE OF YOUR EARNINGS PACKAGE.

The Mahindra **FURIO** is the ideal ICV with multiple options and a host of features for delivering any shape or weight of e-commerce parcels. But what makes this truck the best choice in its class is the assurance of three times the earnings per year*.

Read on to know how the Mahindra FURIO delivers this unmatched promise.

-  Higher mileage means more savings
-  Higher volumetric payload turns into bigger earnings on every trip
-  Higher vehicle reliability
-  Superior driving performance
-  Higher ride comfort allows drivers to make more deliveries
-  Longer body length models for transporting large goods with ease
-  Fleet Management Control



DELIVER MORE, WHATEVER THE CHASSIS LENGTH.

The Mahindra **FURIO** gives you the option of multiple chassis lengths. And no matter what you choose, you get more payload by volume. Making every model a truly profitable one.

- Longer chassis length suitable for large cargo
- Strong chassis for container gives confidence to carry more
- Lower chassis weight gives you higher volume payload



Higher Volumetric Payload		Specifications
Product (CBC)	Payload	Container LxWxH External Dimensions (mm)
FURIO 11	7.8T @ 6706 mm	6796 x 2298 x 2266
FURIO 12		6186 x 2430 x 2440, 6796 x 2430 x 2440, 7225 x 2430 x 2440
FURIO 14	10T @ 7315 mm	
FURIO 16	11.5T @ 6706 mm	6186 x 2520 x 2440, 6796 x 2520 x 2440
FURIO 17	12.4T @ 7315 mm	7405 x 2520 x 2440

MODEL TECHNICAL SPECIFICATIONS - E-COMMERCE AND PARCEL



Model	FURIO 11	FURIO 12	FURIO 14	FURIO 16	FURIO 17
GVW	11280 kg	11990 kg	14050 kg	16140 kg	17000 kg
Tyres	235/75 R 17.5	8.25 R 20		9.0 R 20	275/80 R 22.5
Engine	mDi Tech, 4 Cylinder, BS-VI (EGR + SCR Technology)				
Max. Power	103 kW @ 2400 r/min				
Max. Torque	525 Nm @ 1250-1800 r/min (With Multimode)				
Transmission	MNT 55, 6 speed Overdrive Synchro Gearbox				
Clutch Diameter	362 mm				
Chassis (mm)	HSLA 550, 210 x 65 x 5	HSLA 550, 210 x 65 x 6		HSLA 550, 212 x 65 x 7	
Fuel Tank	160 litre	190 litre		235 litre	330 litre
Suspension	Front : Parabolic, Rear : Semi Elliptical				
Brakes	8 Bar System		10 Bar System		
Cabin	2.05 m Day	2.05 m Day		2.05 m Day, Sleeper	Sleeper
Load Body Length	5334 mm, 6711 mm	5796 mm, 6100 mm, 6711 mm, 7320 mm		5798 mm, 6098 mm, 6711 mm, 7315 mm	
Load Body Width	2135 mm	2135 mm, 2288 mm		2288 mm, 2374 mm	2374 mm

E-COMMERCE AND PARCEL MODEL - FEATURES

Features	FURIO	Comp. 1	Comp. 2	
Engine	Hydraulic Lash Adjuster	√	x	x
	Auto Belt Tensioner	√	x	x
Safety	Cab - Energy Absorbing Mounts	√	x	x
	Wide Spread Fog Lamps	√	x	x
	Neutral Safety Start Switch	√	x	x
	Anti-Roll Bar	√	x	Option
	Wire Mesh @ Fuel Tank Neck	√	x	x
Comfort	SL Berth - Day Cab*	√	x	x
	Lounging Arrangement	√	x	x
	(Co Driver Side)			
	Air Outlets - Ventilation	8# Vents	4# Vents	4# Vents
	5 Deg. Cooler Cab	√	x	x
	(Lower Rake Angle Design)			
	Centre Seat cum Storage	√	x	x
	Day Cab			
	Sleeping Provision – Day Cab	√	x	x
(Centre Seat)				
Convenience	Roof Luggage Carrier / Aero Kit	√	x	x
	Mounting Provision			

MILEAGE, THE BIGGEST REASON FOR Mahindra FURIO'S PROFITABILITY.

The Mahindra **FURIO** gives nothing less than the best mileage among ICVs in India. With fuel costs rising the way they are, this truck is the biggest game changer for your business.

- Best-in-class mileage
- Needs lower AdBlue, gives you more savings
- Smooth performance leads to extra trips and more earnings

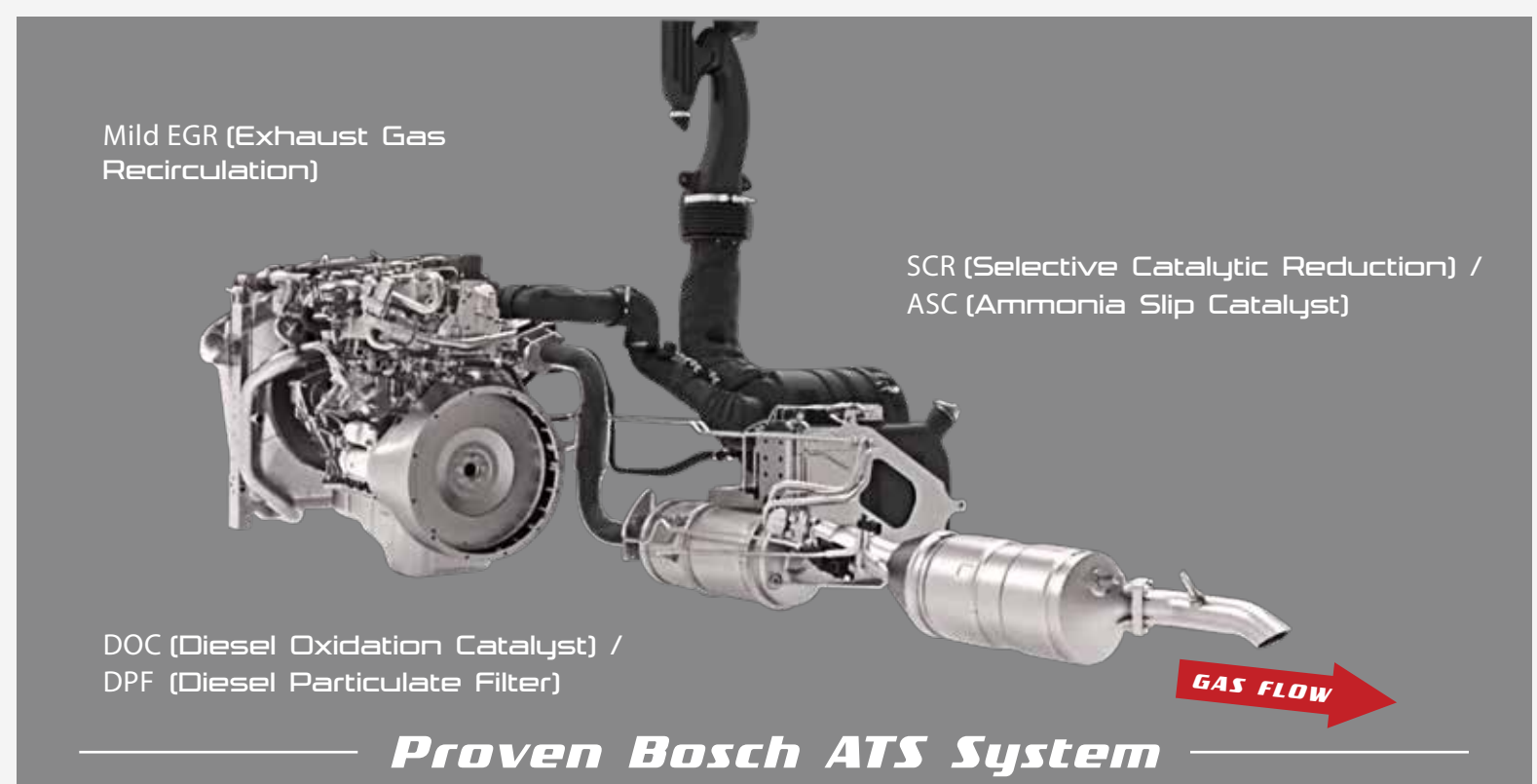

RELIABILITY THAT CONTRIBUTES TO GREATER EARNINGS.

This truck has such a high degree of reliability that doing business smoothly becomes an absolute certainty. In other words, you can depend on the Mahindra **FURIO** to quietly deliver consistently high performance trip after trip. And its build quality makes breakdowns a long-faded dream.

- Same rugged aggregates for unflinching reliability
- Consistent and reliable performance for on-time deliveries
- Allows drivers to clock more kilometres every month
- Minimal changes from BS4 to BS6 ensures similar high payload capacity



362 mm Diameter
Organic Clutch



High Strength Low Alloy
Material (HSLA 550)



Heavy-Duty Rear Axle
Meritor

HAPPIER DRIVERS MAKE FOR MORE PRODUCTIVE DRIVERS.

The Mahindra **FURIO** makes driving more comfortable. This allows drivers to make more trips which in turn contributes significantly to your earnings. In fact the driver's comfort was an overlooked factor for many years. But Mahindra **FURIO** has changed that completely.

- Space enough for two drivers
- Roomy cabin, with lower noise and vibration
- Ample resting space in cabin during stopovers; means less tiredness over long drives
- Well-ventilated cabin brings down temperatures; especially in hot conditions
- Cabin provides higher operational comfort
- Gives you market rate business edge by making on-time delivery possible
- Comfort that makes night-driving less of an effort
- Good cabin ergonomics leading to higher trip efficiency



Day Cabin



Sleeping Provision Day Cab*



Lounging Arrangement



Sleeper Cabin



Spacious Sleeper Cab, Comfortable Sleeper Berth



Lower Rake Angle Design



Walk-Through Cab



5°C Cooler Cab, 8 Air Vents, Soft Touch PU Steering Wheel



Parabolic Suspension

Fabric Seats



WITH MORE SAFETY COMES MORE ASSURANCE.

The Mahindra **FURIO** has several safety features to not only make drivers feel safer at higher average driving speeds but also give you the assurance of cargo safety. This is another reason why this truck is ideal for drivers and an important addition to your fleet, especially for perishable goods.



Widespread Fog Lamps for Excellent Visibility at Night and in Dark Conditions

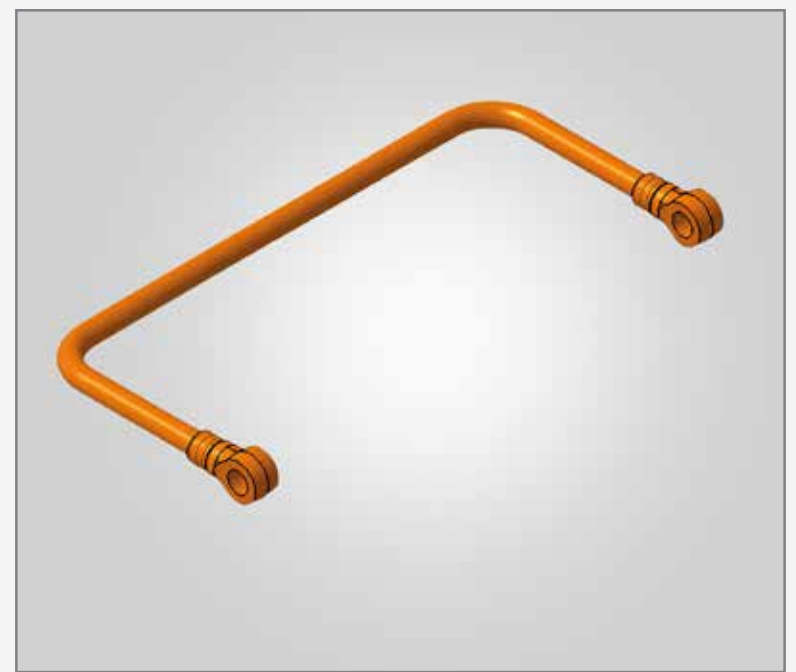

Front Anti-Roll Bar (ARB) for Greater Stability on the Road

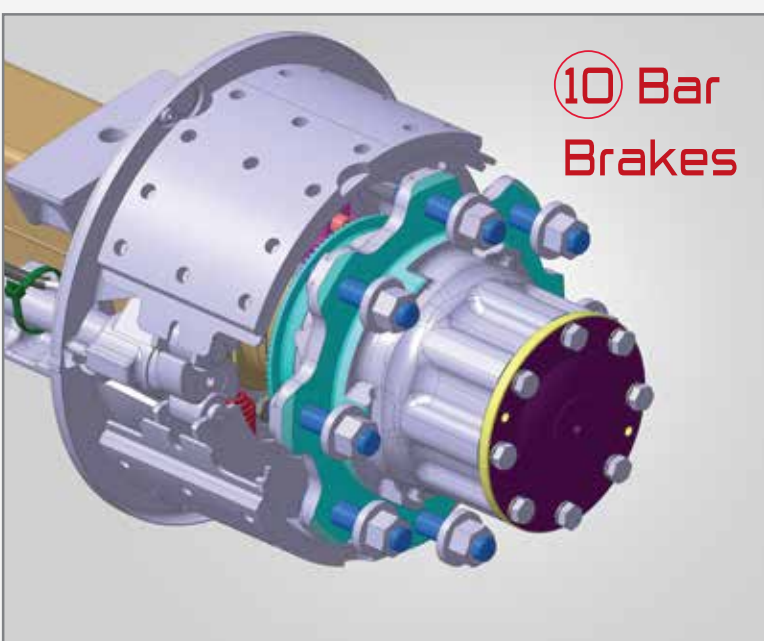

10 Bar Braking System for Quick, Short Stops

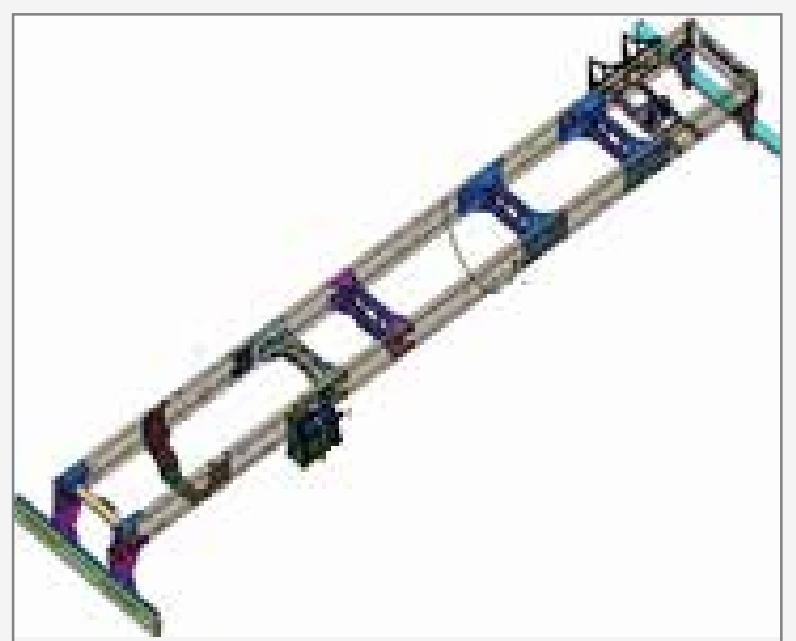
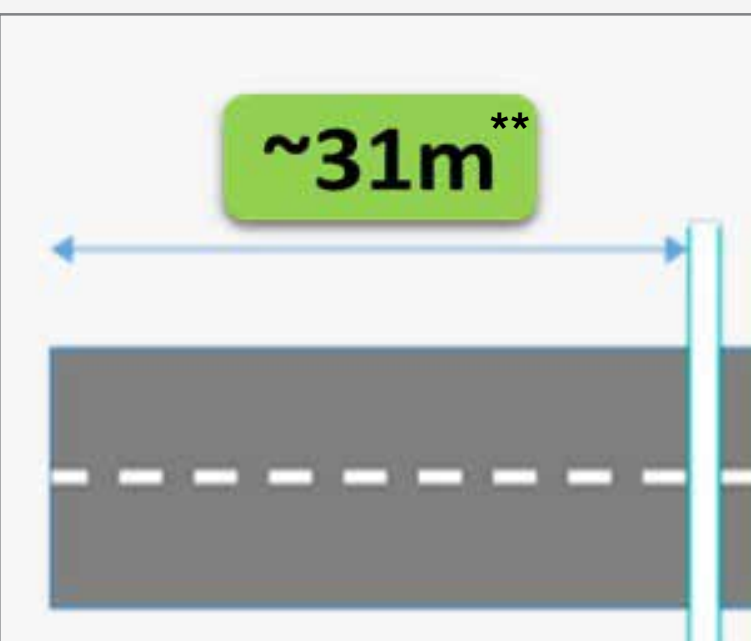

High Strength Low Alloy Chassis for Higher Strength and a Greater Sense of Security



Safest Cabin with Best-in-Class Survival Space



Tubeless and Radial Tyres* for High Speed Capacity, Better Stability And Puncture Resistance



Think of the Mahindra iMAXX telematics technology as your personal assistant that updates you with vital information about your vehicles and business. Mahindra iMAXX comes with smart features like Accurate Refills, Live Tracking, Predictive Vehicle Health Monitoring, Fuel Efficiency Analysis, Theft Alerts, Fuel Consumption, Adblue Monitoring, Driver Behaviour Monitoring and a range of Automated Operation Reports. With the help of these features, owners can keep track of their vehicles and business 24/7.*

KEY FEATURES



PERSONALISATION

As your business evolves, so does our technology to suit all your needs.



ZERO DATA LOSS

It's equipped with a bigger battery and memory to store data. In addition, it also works on all generations - 4G, 3G and even 2G.



100% RELIABILITY

Mahindra iMAXX is backed by artificial intelligence so you get accurate results every day.



SMART REPORTS

Gives analytical insights and reports regularly to monitor and grow your business.



VEHICLE HEALTH MONITORING

- Provides fault codes and repair strategies
- Displays battery and alternator condition
- Engine temperature display
- Turbocharger and intercooler information



FUEL AND ADBLUE ANALYSIS

- Fuel economy analysis
- Fuel filling and theft monitoring
- Adblue monitoring
- EV battery monitoring



DRIVER BEHAVIOUR MONITORING

- Gear utilisation information
- Idling time monitoring
- Hard braking and harsh acceleration alerts
- Over-speeding alerts



OPERATIONS AUTOMATION

- Hub report
- Vehicle utilisation report for enhancing overall efficiency
- Vehicle live data for course correction
- Location track and trace



Mahindra AASHRAY is an insurance policy for truck and bus drivers that comes free with every Mahindra truck and bus. It provides financial support up to Rs. 5 Lakh in case of loss of limb or life. It's our way of showing how deeply we care about the welfare of drivers. It's our way of making every Mahindra truck or bus even more complete.*



Mahindra MCOVER makes you feel 3 times more secure.

- ① Cashless and Zero Depreciation Settlement*
- ② New vehicle replacement in case of total loss*
- ③ Compensation for loss of income*



Mahindra brings you MTRUST, the best way to buy and sell used Mahindra trucks and buses. We inspect each vehicle from bumper to bumper through 166 check points at our authorised dealerships under company trained mechanics and make them go through 36 tough health checks as well. If there are any worn-out/non-working parts, we refurbish them with genuine Mahindra spares to give you vehicles that are as good as new and outperform from the word go.*

LOCATE A SERVICE CENTRE WHEREVER YOU ARE.

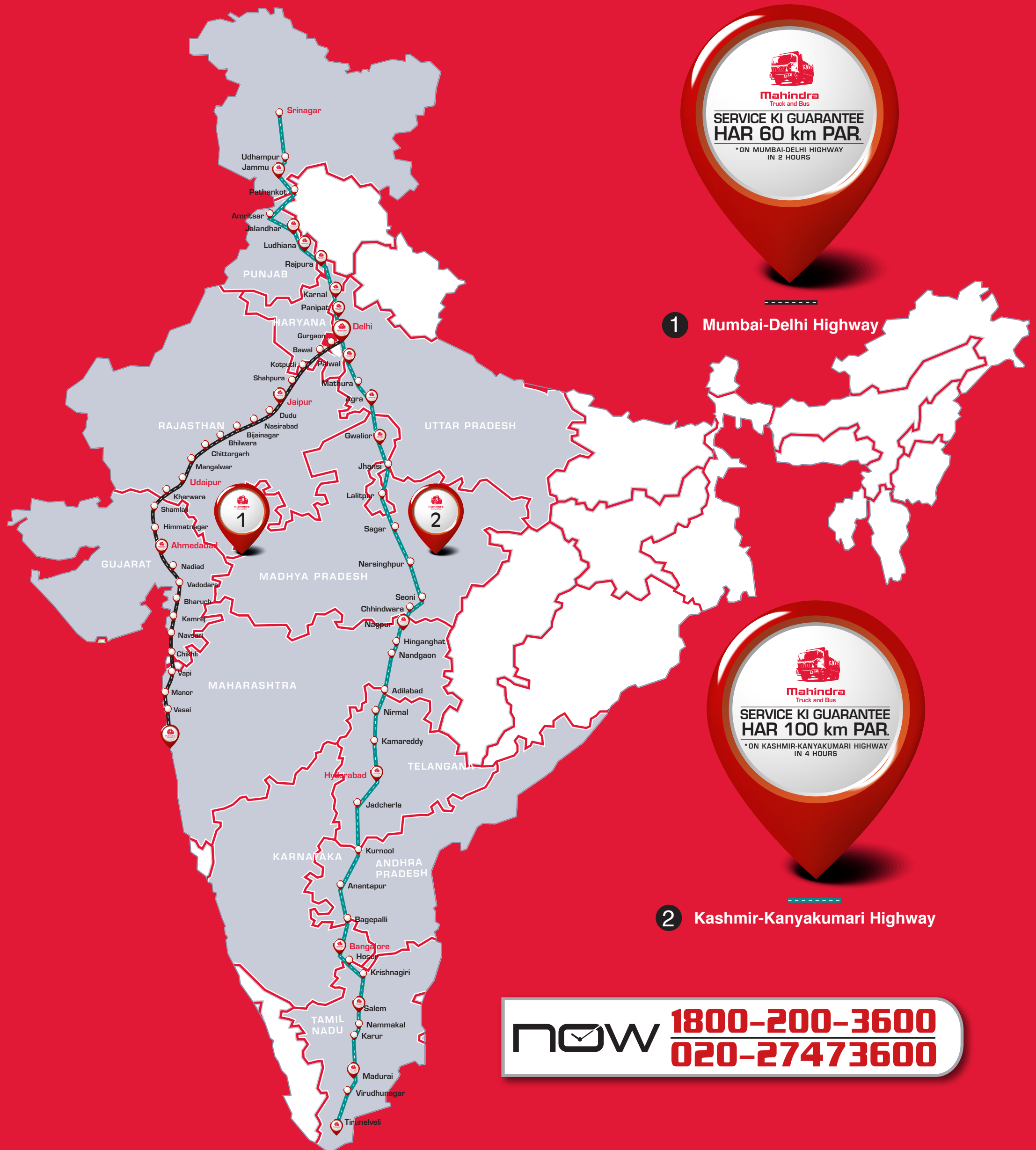

now 1800-200-3600
020-27473600

OUR GUARANTEES

GET BACK ON ROAD IN **48 HOURS** OR GET **₹1 000.00** PER DAY.*

GET A **36-HOUR** GUARANTEED TURNAROUND AT OUR WORKSHOPS OR GET **₹3 000.00** PER DAY

GET THE **HIGHEST MILEAGE** OR GIVE THE TRUCK BACK



Mahindra brings you MTRUST, the best way to buy used Mahindra trucks. We put each vehicle through 166 tough health checks. Refurbish with only Mahindra spares. All to give you trucks that are as good as new and outperform right from the start.

- UP TO 12 MONTHS WARRANTY • 1/2/3 STAR RATINGS • UP TO 3 FREE SERVICES • ROADSIDE ASSISTANCE • REFINANCE OPTIONS

Corporate: contactmtb@mahindra.com
Customer Care: now24x7@mahindra.com

www.mahindratruckandbus.com

Mahindra & Mahindra Ltd.,
Truck and Bus Division, Marketing Division,
2nd Floor, Mahindra Towers, Worli, Mumbai 400 018.

Note: In view of our policy of continuously improving our products, we reserve the right to alter specifications or design without prior notice and without liability. Illustrations do not necessarily show the vehicle in its standard form. Accessories shown are not part of the standard equipment. Colour shades shown may vary. E. & O.E.

DEALER STAMP

To know more give us a missed call on:
1800 315 7799

visit www.mahindratruckandbus.com

MOBILE SERVICE VANS & WORKSHOPS

COUNTRY-WIDE SPARES & SERVICE NETWORK

*For details of this guarantee, please refer to the website www.mahindratruckandbus.com